

Cut-out pattern in extrusion
to allow internal and external
curves to be formed

PLAN
SCALE 1:4

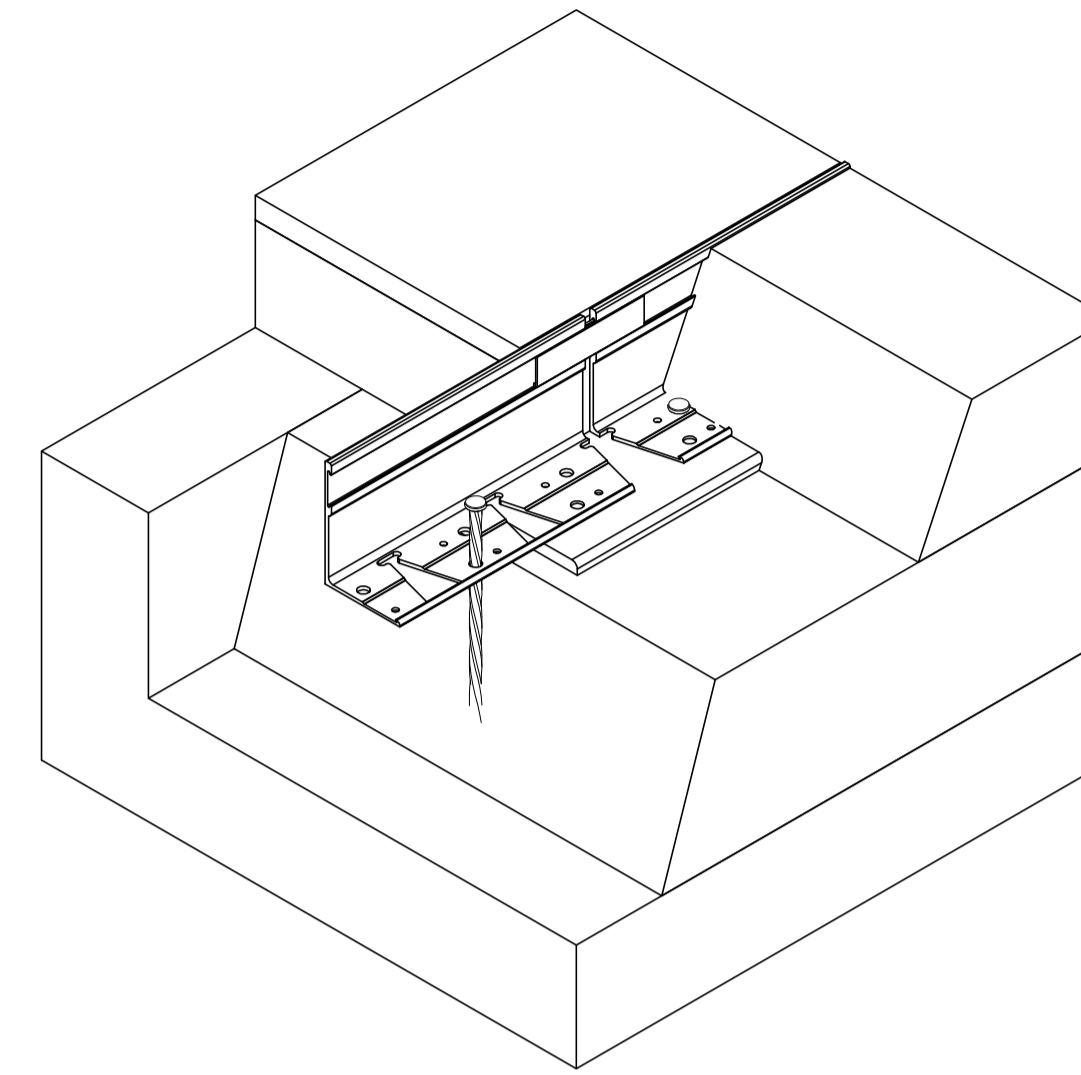

ISOMETRIC CUT-AWAY VIEW
NTS

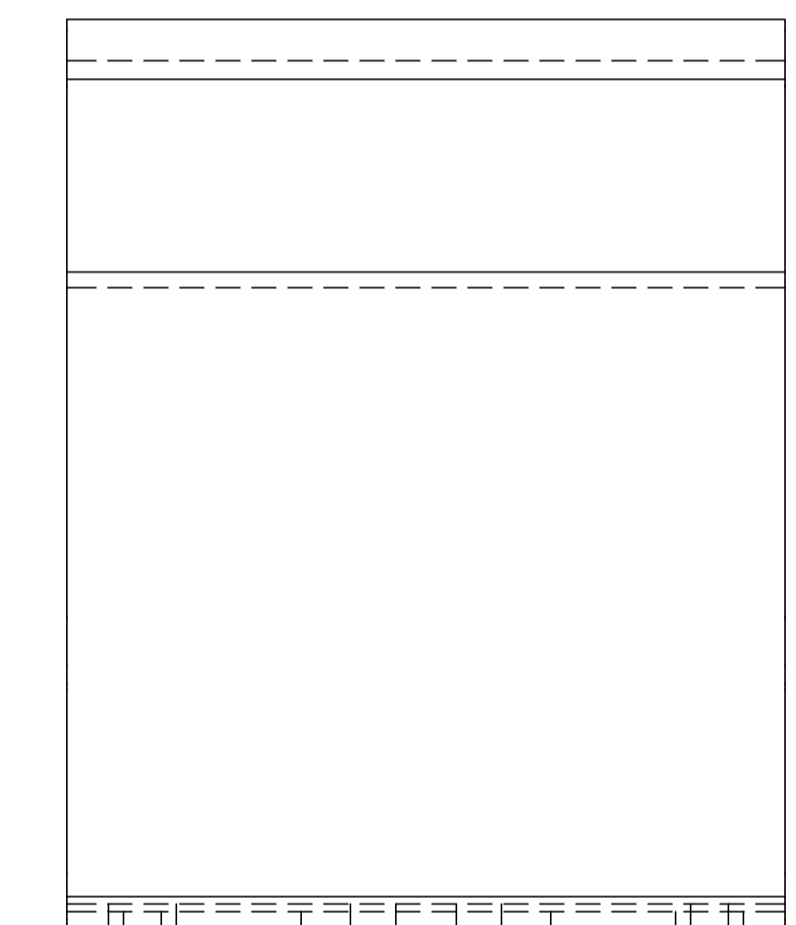
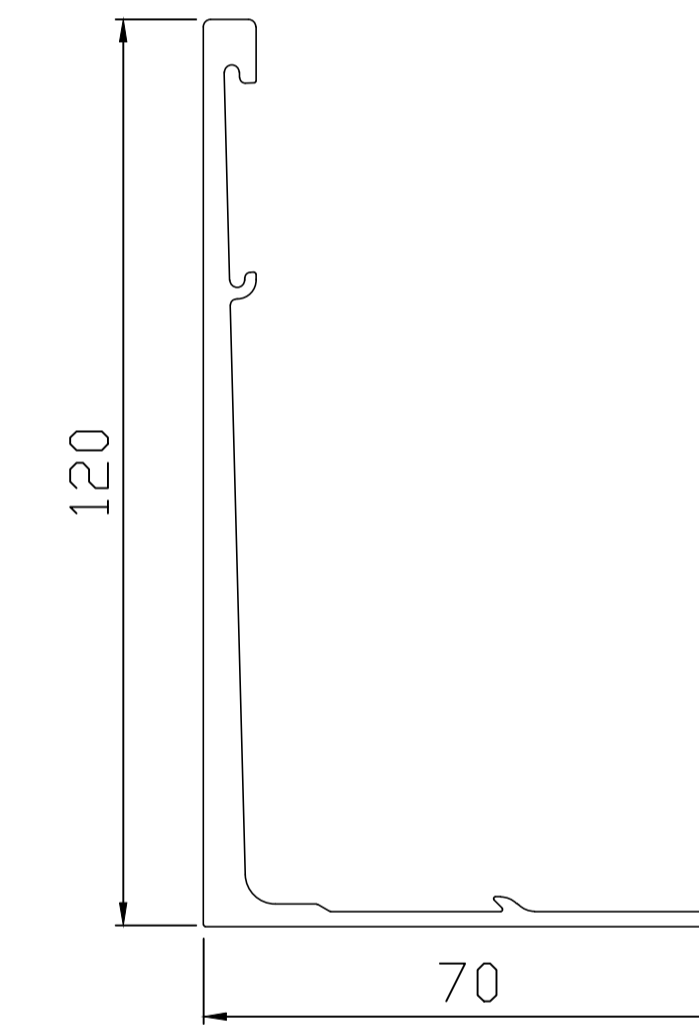
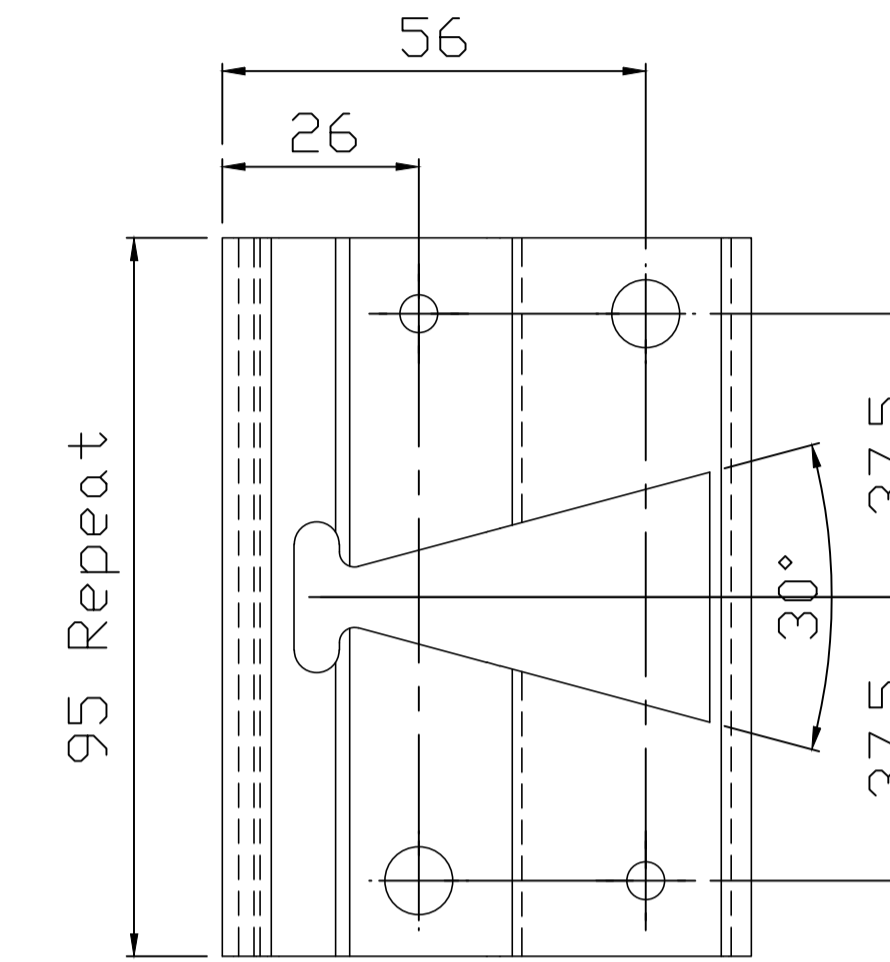

PROFILE DETAIL
SCALE 1:1

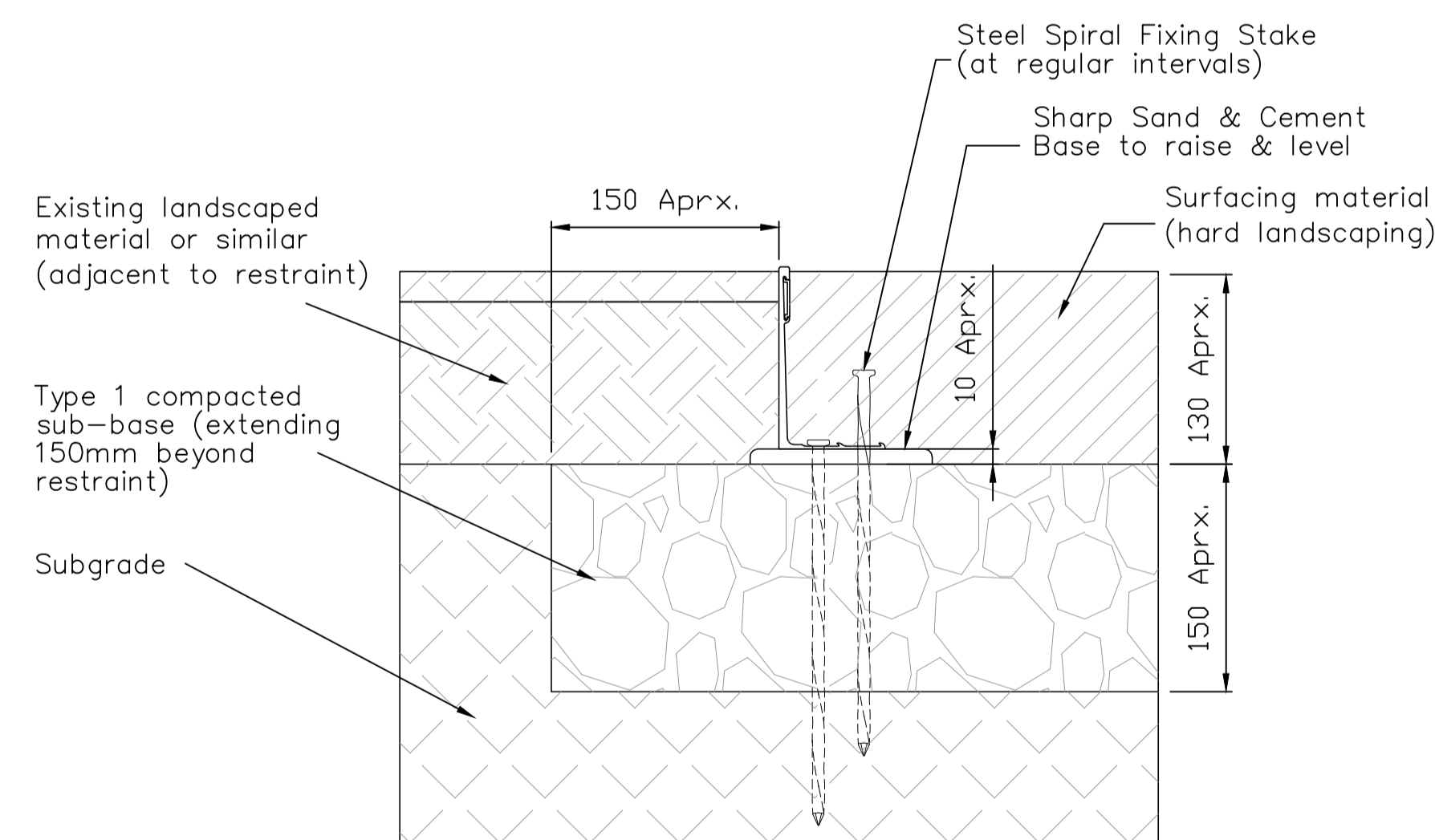

SECTION
SCALE 1:4

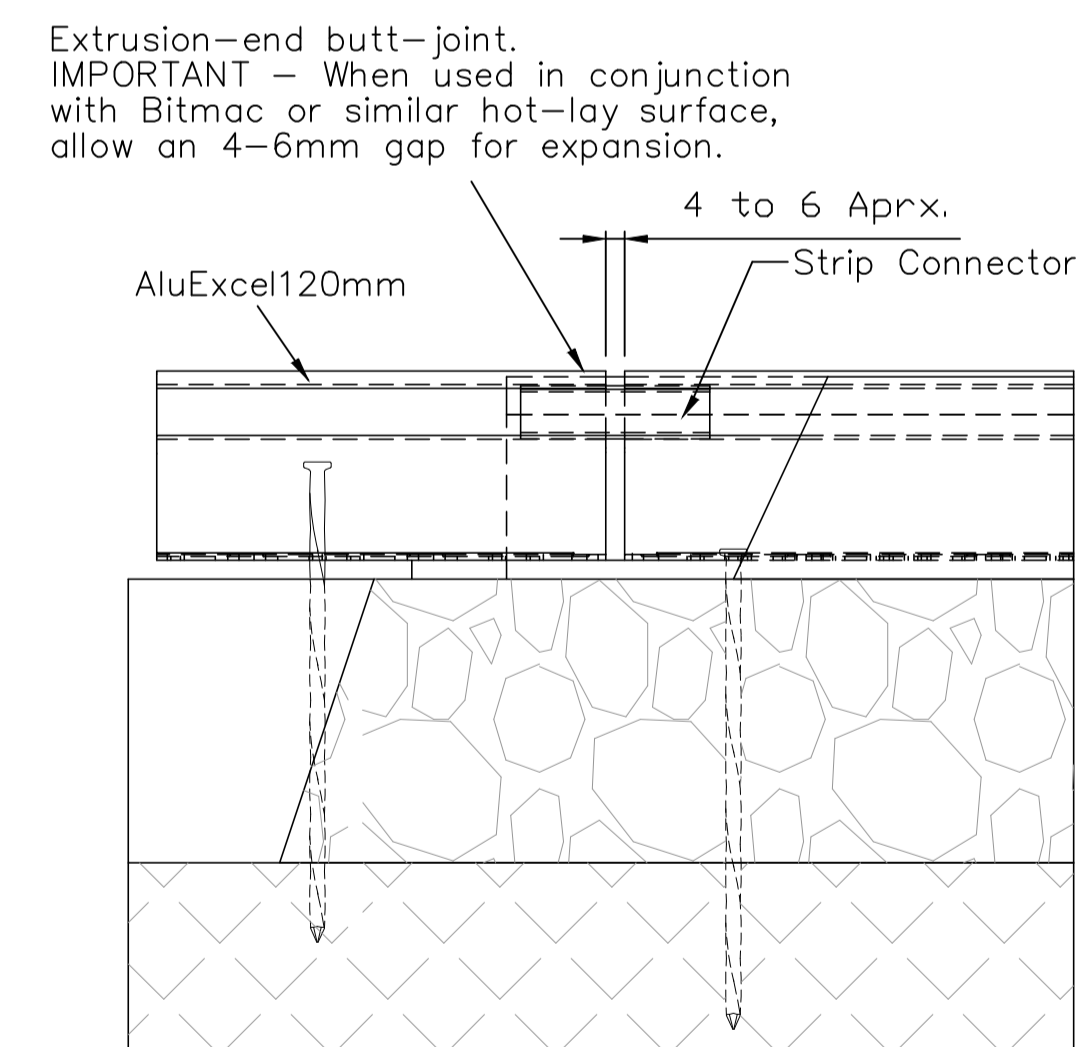

JOINER DETAIL
SCALE 1:4

Note: AluExcel can be used in conjunction with sub-base materials other than those shown. Please contact our technical team on (0)1580 830688 to discuss your requirements.

Title				AluExcel 120 - Cad Drawing			
Scale	1:4	Size	A1	Sheet	1/2	Drawing No.	CD-AE120-1217
Edging	ExcelEdge	AluExcel					
Division	Collection	Range					
Kinley Systems Ltd, Northpoint, Compass Park, Staplecross, East Sussex, TN32 5BS +44 (0) 1580 830688 / sales@kinley.co.uk www.kinley.co.uk							 INSPIRED PLACES MADE POSSIBLE