

Cut-out pattern in extrusion to allow internal and external curves to be formed

PLAN
SCALE 1:4

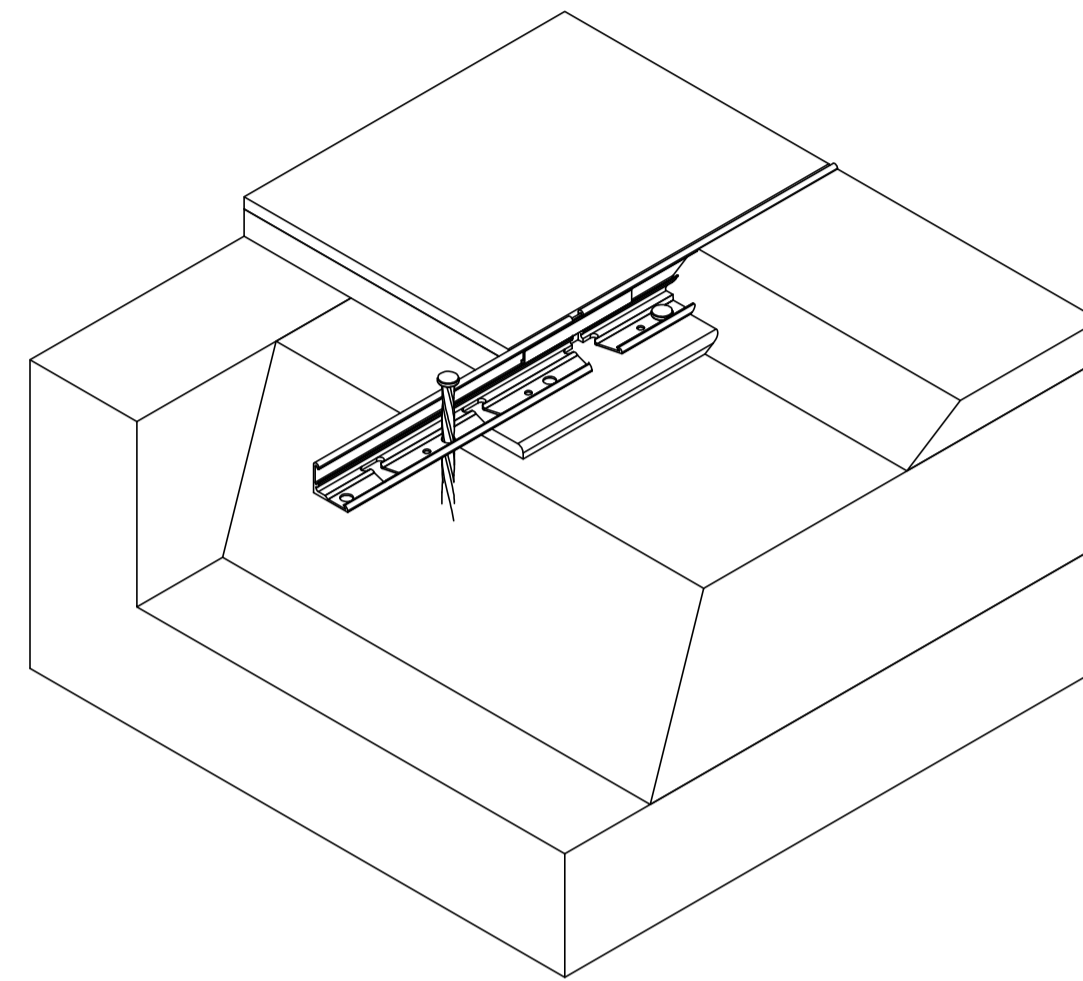

ISOMETRIC CUT-AWAY VIEW
NTS

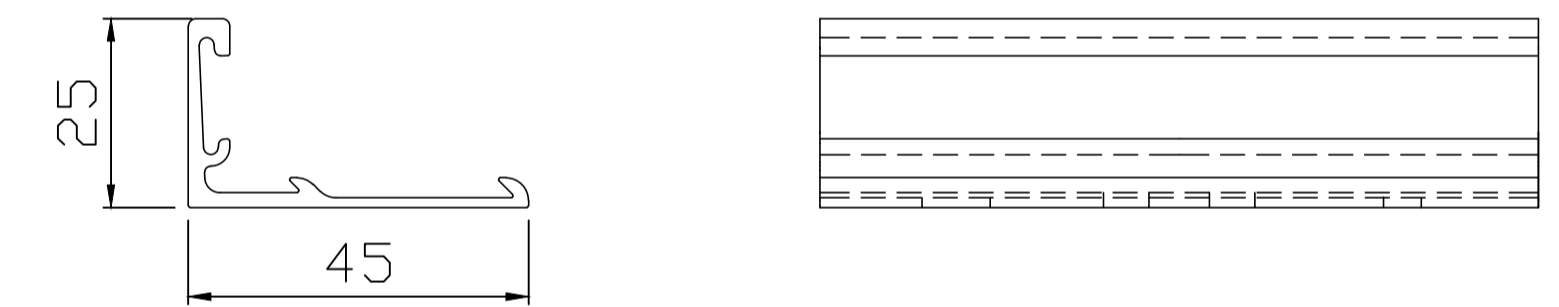
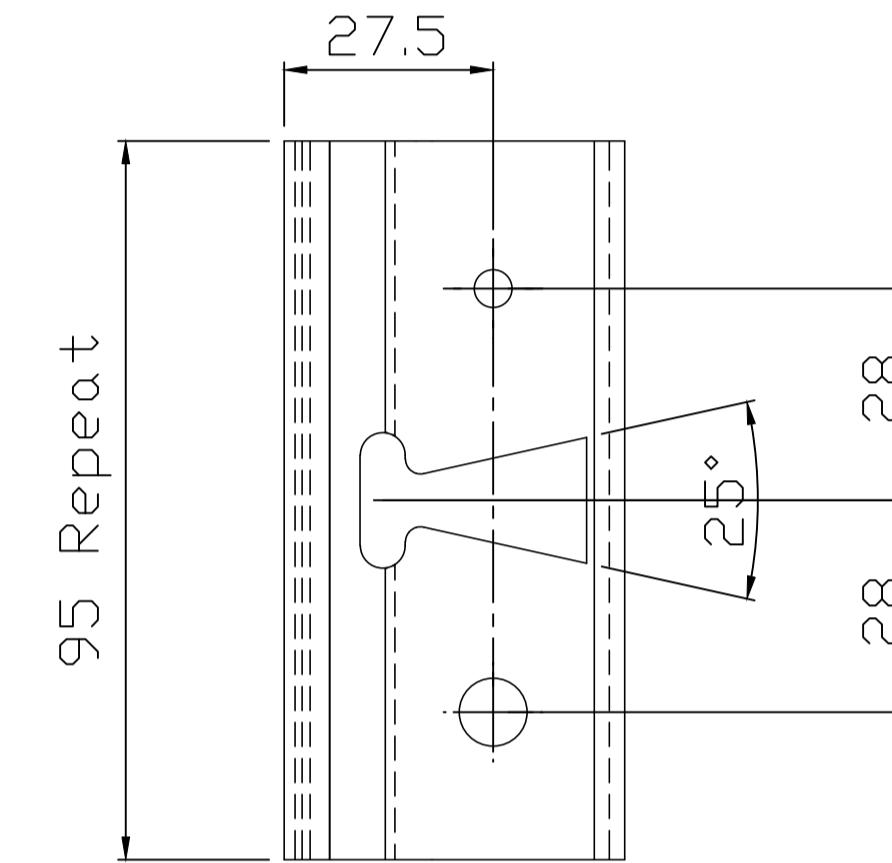

PROFILE DETAIL
SCALE 1:1

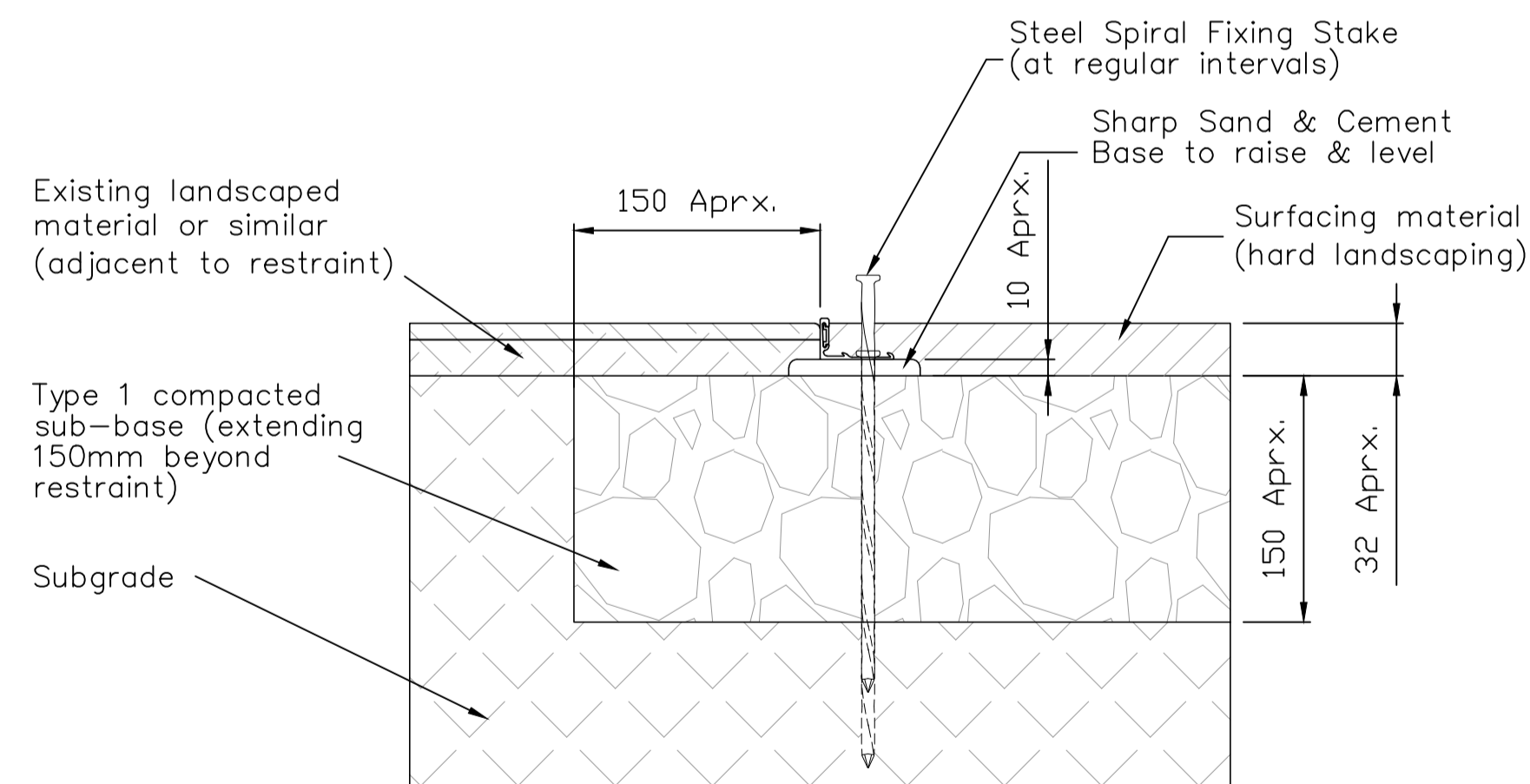

SECTION
SCALE 1:4

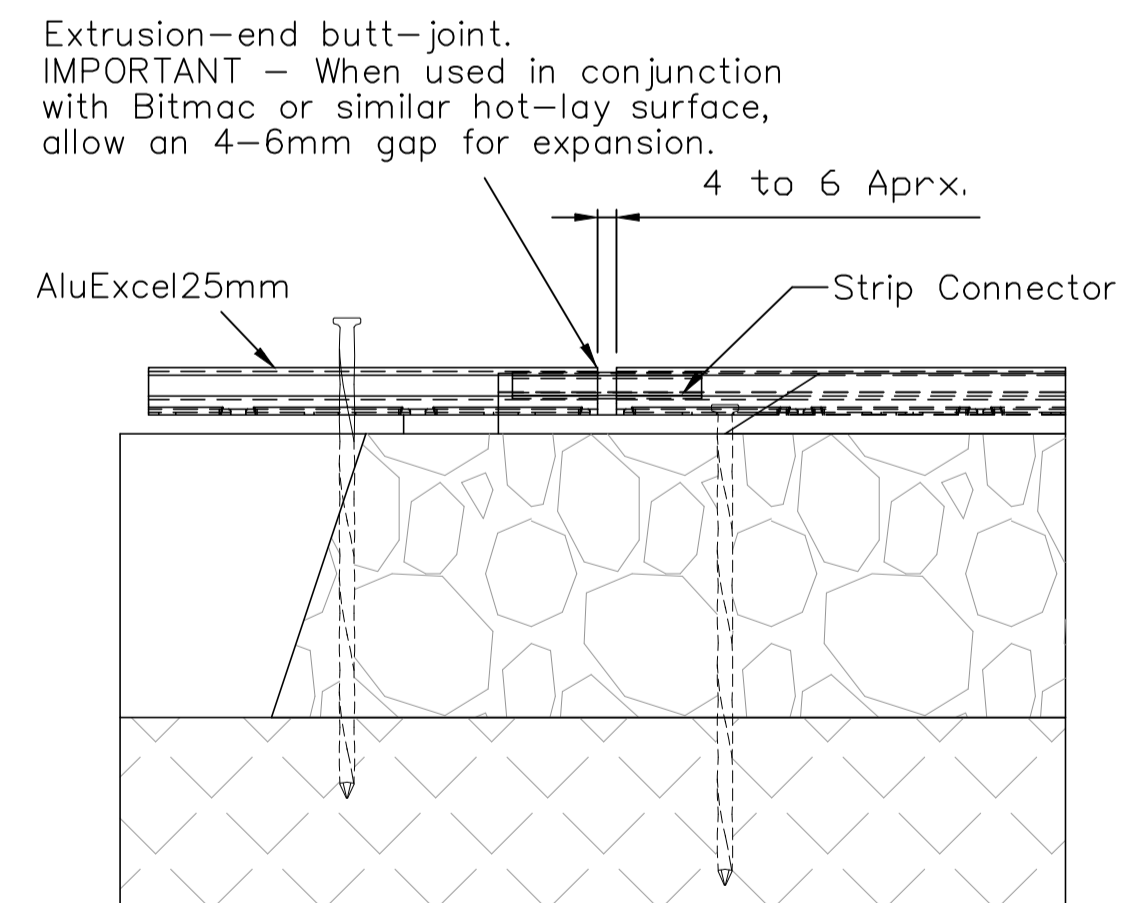

JOINER DETAIL
SCALE 1:4

Note: AluExcel can be used in conjunction with sub-base materials other than those shown. Please contact our technical team on (0)1580 830688 to discuss your requirements.

Title				AluExcel 25 - Cad Drawing	
Scale	1:4	Size	A1	Sheet	1/2
Drawing No.				CD-AE25-1217	
Edging	ExcelEdge	AluExcel	Division	Collection	Range
Kinley Systems Ltd, Northpoint, Compass Park, Staplecross, East Sussex, TN32 5BS +44 (0) 1580 830688 / sales@kinley.co.uk www.kinley.co.uk					
					INSPIRED PLACES MADE POSSIBLE